

E40



IP 66



IK08

**CONSTRUCTION**

Housing: aluminium powder painted casting

Diffuser: borosilicate tube glass

Accessories: protected galvanized steel gird, assembly kit for wall, pipe and ceiling mounting

TECHNICAL DATA

Certificate:	EXA 14 ATEX 0047 RU C-HR.AB24.B.03248
Marking:	CE 0722
Apparatus category:	II 2GD
Marking of explosion protection:	 Ex db eb IIC T4-T3 Gb Ex db IIC T4-T3 Gb Ex tb IIIC T130°C - T195°C Db
Ambient temperature:	-20°C ≤ Ta ≤ +40°C [ATEX] -50°C ≤ Ta ≤ +40°C [EAC]
Degree of protection:	IP 66, category 1
Resistance to shock:	IK 08
Protection class :	I (protective earthing)
Rated voltage:	RLF/... HIT,HST,HME,QT -230/240 V (-10% / +6%) / 50 Hz RLF/... QL -230 V (200-277 V) - 50/60 Hz or (190-264 V) - DC
Frequency:	50Hz (60Hz on request)
Rated power:	See model code table
Light output ratio:	η=0,60%
Cable entry:	RLF/... HIT,HST,HME,QT - three entries M20, with two Ex d plug and one Ex de adapter, type ADP 23/1, for cable φ7-15 mm RLF/... QL - two entries M25 into Ex e junction box with one Ex e cable gland, type SPU 25, for cable φv 7-15 mm and one Ex e plug
Connection terminals inside light fitting	RLF/... HIT,HST,HME,QT -clamps in Ex d e adapter for connection L1, L2, N, PE, 2,5mm ² max. / clamp - solid, stranded;
External PA / PE terminal:	max 2 x 6 mm ² flexible, 3 pcs.
Weight:	See model code table
Packing:	The packing contains: 1 pcs 600x400x300 mm

- Up to 400W discharge sources
- QL source up to 100 000 hours life time

MODEL CODE

Model code	Max. wattage	Lamp type	Luminous flux	Lamp holder	Temp. class (gas)	T ₀ MAX (dust)	Weight
					T _a =40°C	T _a =40°C	
RLF/250 HIT	250 W	HIE	20000	E40	T4	130°C	25 kg
RLF/250 HST		HST	33200				
RLF/250 HME		HME	13000				
RLF/400 HIT	400 W	HIE	34000		T3	190°C	27 kg
RLF/400 HST		HST	56500				
RLF/500 IQT	500 W	IQT	10 250		QL	T4	130°C
RLF/85 QL	85 W	QL	6300				
RLF/165 QL	165 W	QL	12000				

POLAR CURVE

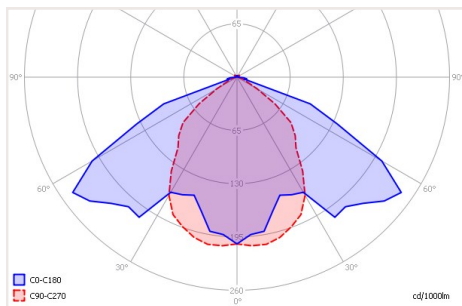

Wide beam reflector

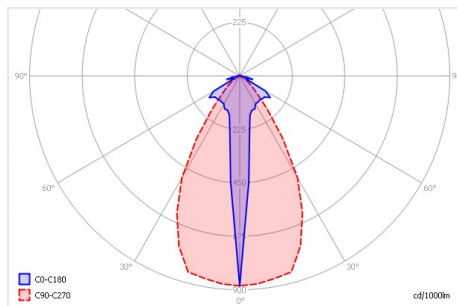

Narrow beam reflector

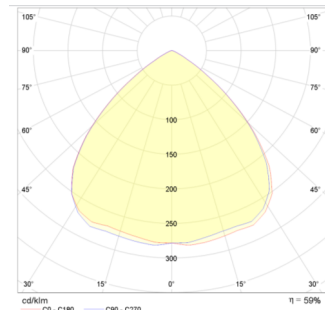

QL 165 W



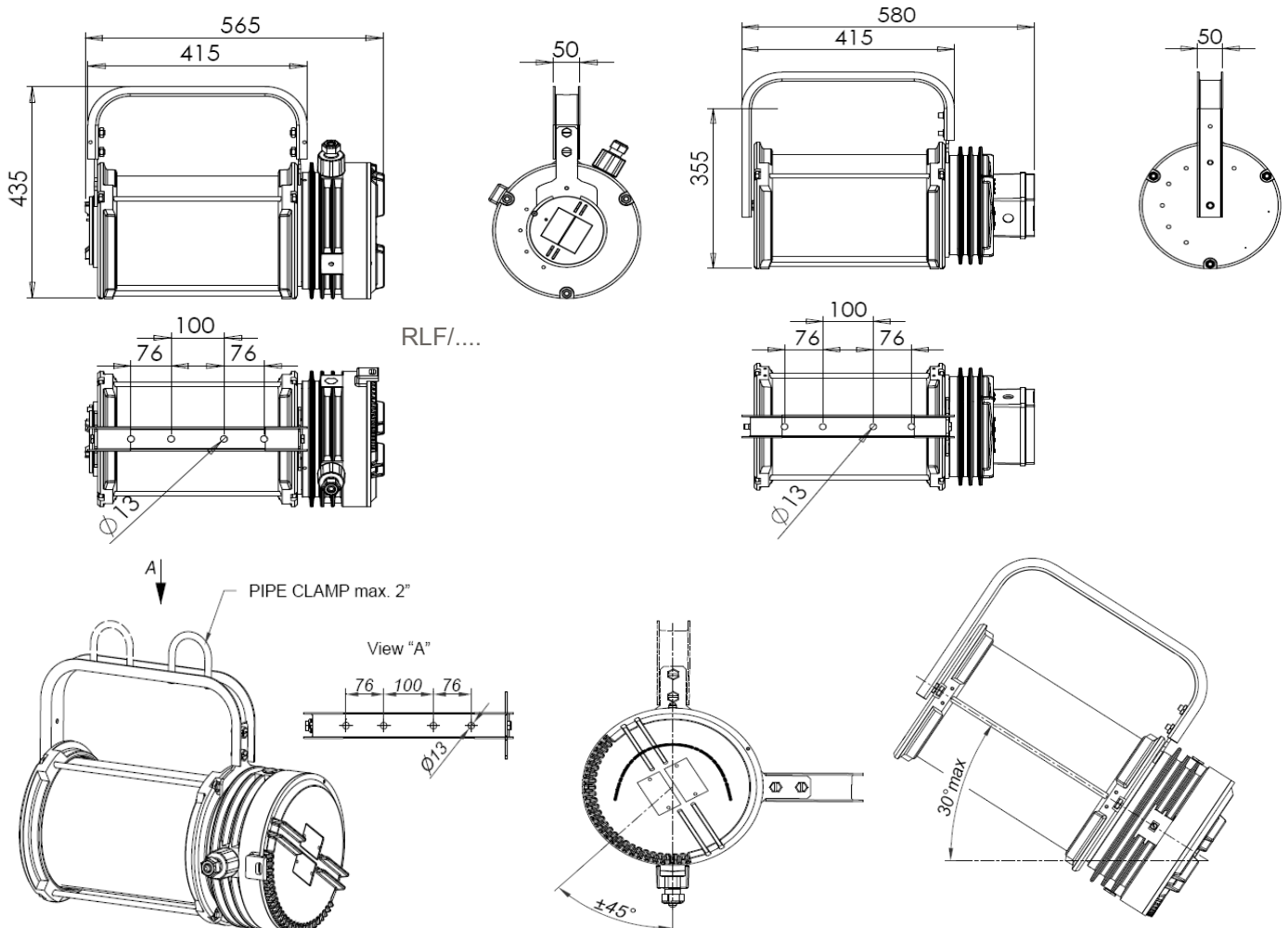





DIMENSION DRAWING (all dimensions in mm)





All technical data is relevant at the time of print.

SPARE PARTS AND ACCESSORIES

If it is not ordered differently, floodlight **RLF/ ... HIT,HST,HME,QT** presume floodlight with RLF carrier, one Ex de adapter ADP 23/1 and two Ex d plugs, without light source and mounting accessories. Manufacturer will deliver spare parts and accessories on buyer request.

Sketch	Description	Code	Sketch	Description	Code
	Light source	RLF 10-110		Base plate HME Set	RLF 20-120
	Mounting screw M12x40	RLF 10-120		Gasket RLF	RLF 20-130
	U screw M12	RLF 10-130		Adapter Ex d e	ADP 23/1
	Base plate HIT, HST Set	RLF 20-110		Ex d plug M20	RLF 20-140

If it is not ordered differently, floodlight **RLF/... QL** presume floodlight with RLF QL carrier, one Ex e junction box MMK 13 with Ex e connecting terminals, Ex e M25 cable gland, Ex e M25 plug, and Philips QL Induction Lighting System, without mounting accessories. Manufacturer will deliver spare parts and accessories on buyer request.

Sketch	Description	Code	Sketch	Description	Code
	MMK 13 gasket	RLF QL 10-110		Ex e plug M25	SPC 25
	Ex e cable gland M25	SPU 25			

